

FOR OFFICIAL USE



National
Qualifications
2018

Mark

X835/75/01

Graphic Communication

THURSDAY, 10 MAY

1:00 PM – 3:00 PM



* X 8 3 5 7 5 0 1 *

Fill in these boxes and read what is printed below.

Full name of centre

Town

Forename(s)

Surname

Number of seat

Date of birth

Day

Month

Year

Scottish candidate number

Total marks — 80

Attempt ALL questions.

All dimensions are in mm.

All technical sketches and drawings use third angle projection.

You may use rulers, compasses or trammels for measuring.

In all questions you may use sketches and annotations to support your answer if you wish.

Write your answers clearly in the spaces provided in this booklet. Additional space for answers is provided at the end of this booklet. If you use this space you must clearly identify the question number you are attempting.

Use **blue** or **black** ink.

Before leaving the examination room you must give this booklet to the Invigilator; if you do not, you may lose all the marks for this paper.



* X 8 3 5 7 5 0 1 0 1 *

Total marks — 80
Attempt ALL questions

1. A knife and chopping board storage system is shown below. The body is made from sheet metal. A CAD technician produced the rendered 3D CAD illustration and the pictorial line drawing shown below.

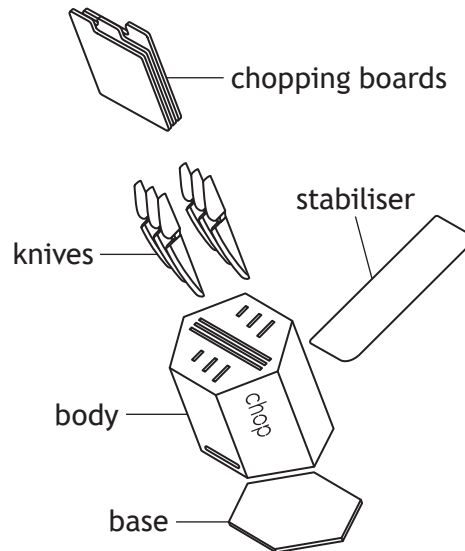
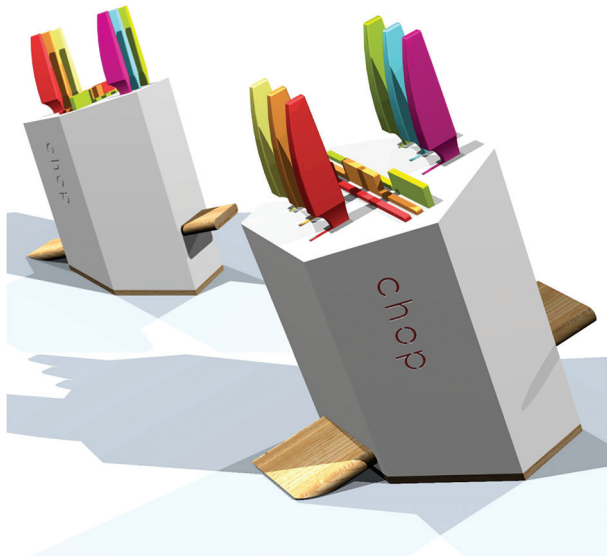

A 3D CAD model rather than a physical model of the storage system was created during the development stage.

- (a) State two reasons why a 3D CAD model was more suitable than a physical model. 2

To produce the CAD model the CAD technician was given information about the storage system. One dimension stated: A/F 300mm.

- (b) State the meaning of A/F. 1

1. (continued)

The CAD technician has been asked to produce an appropriate surface development for the storage system and identify where key features will be placed.

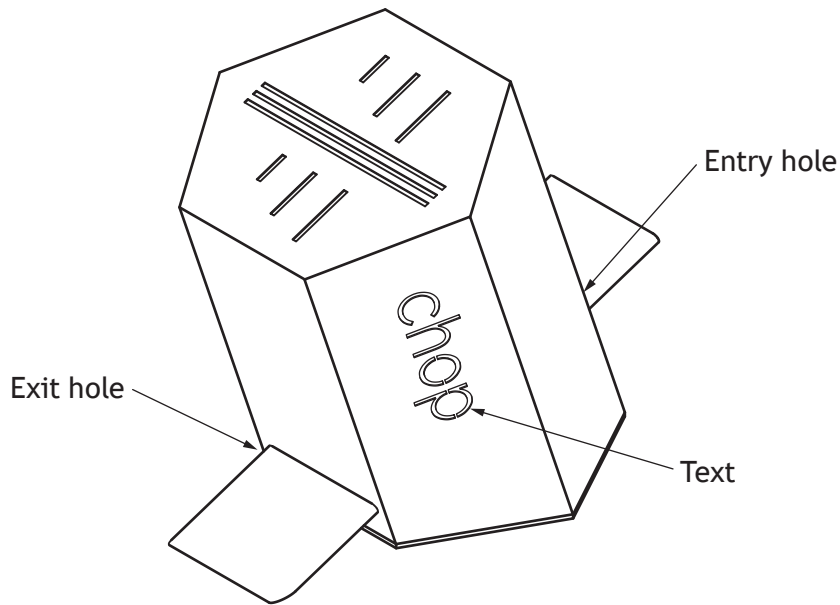

(c) Indicate, on the graphic below, where the Text, Entry hole and Exit hole would be located.

3

Use **A** to indicate on the panel where the Text would be located.

Use **B** to indicate on the panel where the Entry hole would be located.

Use **C** to indicate on the panel where the Exit hole would be located.

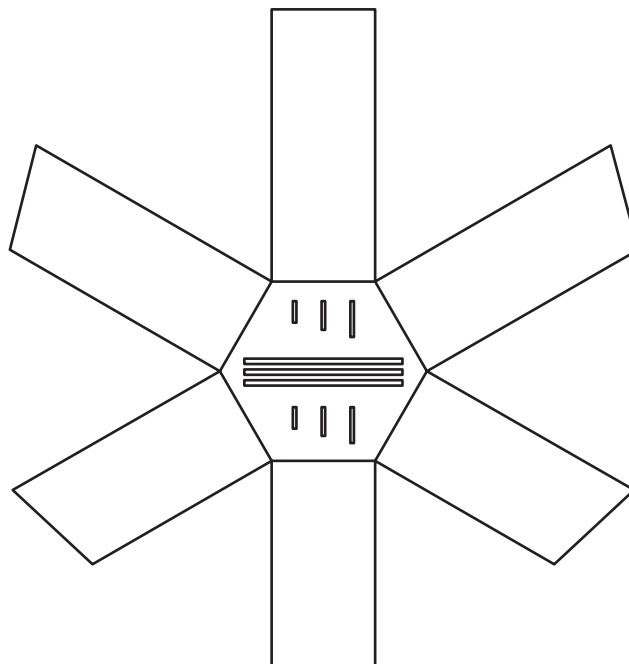

1. (continued)

MARKS
DO NOT WRITE IN THIS MARGIN

To aid the production of the storage system the CAD technician was asked to complete the orthographic drawing shown below.

Hidden detail and slots removed for clarity.

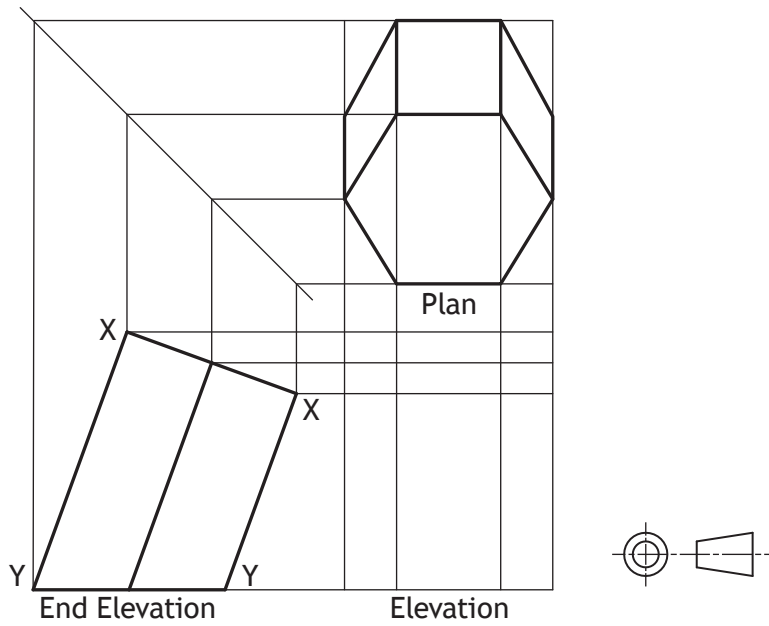

(d) Identify, using a tick (✓), the correct elevation. Ignore wall thickness.

1

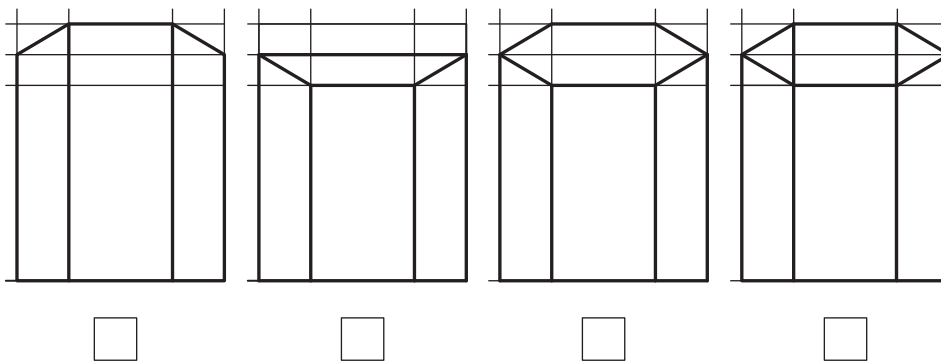

A true shape of surface X-X was required.

(e) Identify, using a tick (✓), the correct true shape. Use a ruler or trammel to measure.

1

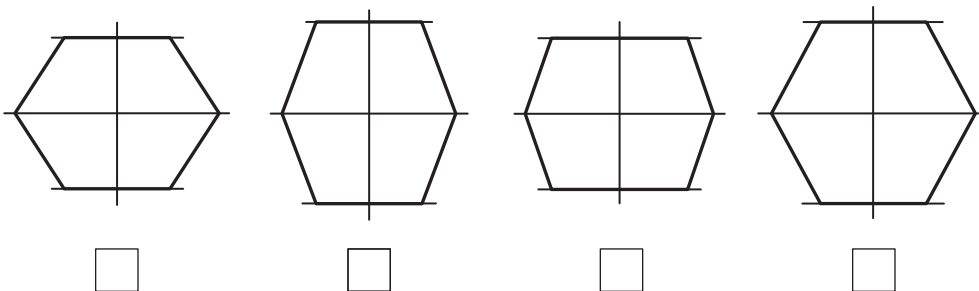



1. (continued)

MARKS
DO NOT
WRITE IN
THIS
MARGIN

A true shape of surface Y–Y was required.

- (f) Identify, using a tick (✓), the correct true shape. Use a ruler or trammel to measure.

1

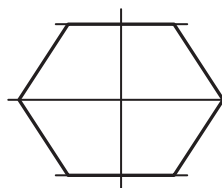
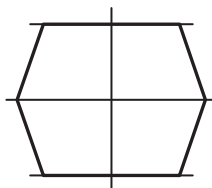
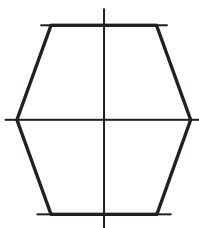
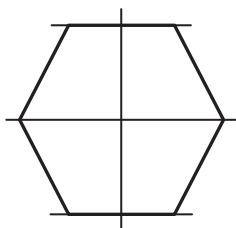

* X 8 3 5 7 5 0 1 0 5 *

1. (continued)

The CAD technician was then asked to provide surface developments of the body of the knife block, without the top.

- (g) Identify the two correct surface developments, shown opposite, of the knife block when opened out at surface generators 'A' and 'B'.

You should refer to the orthographic drawing below.

- (i) When opened out at generator A, the correct surface development is view. 1

Insert number

- (ii) When opened out at generator B, the correct surface development is view. 1

Insert number

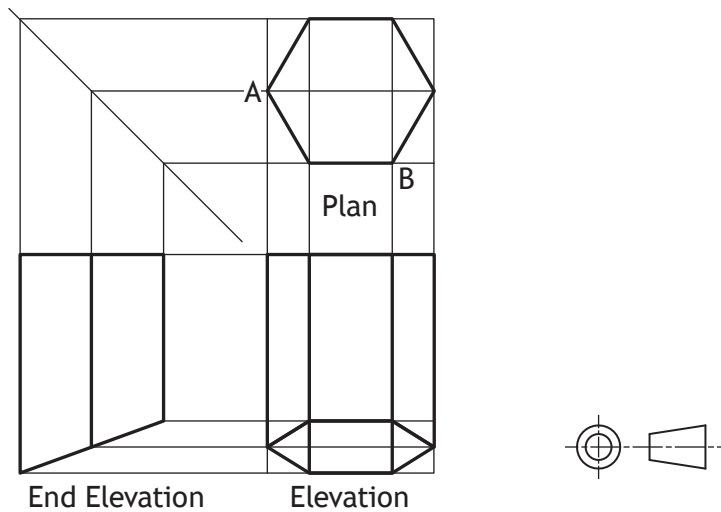

1. (continued)

The range of surface developments are show below.

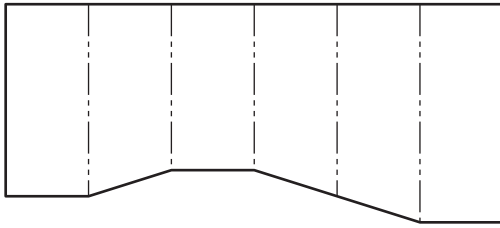

1.

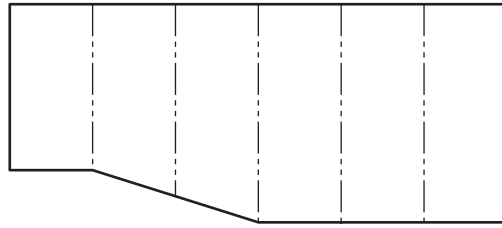

2.

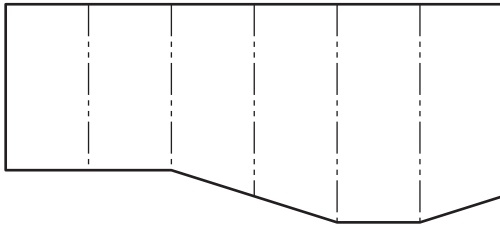

3.

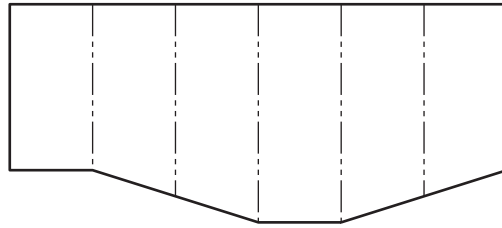

4.

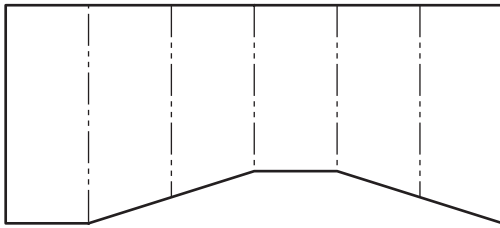

5.

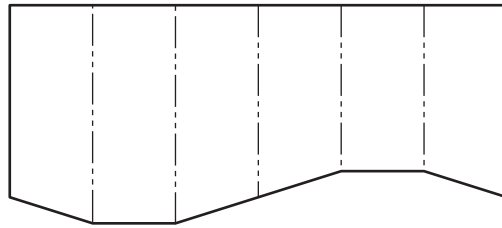

6.

A number of the knife blocks are to be produced from a single sheet of material.

- (h) Explain, in terms of environmental impact, why it is important to carefully consider the layout of multiple parts.

1

[Turn over



1. (continued)

- (i) A knife set to complement the knife block is to be produced. Rendered pictorials and orthographic views of one knife are shown below.

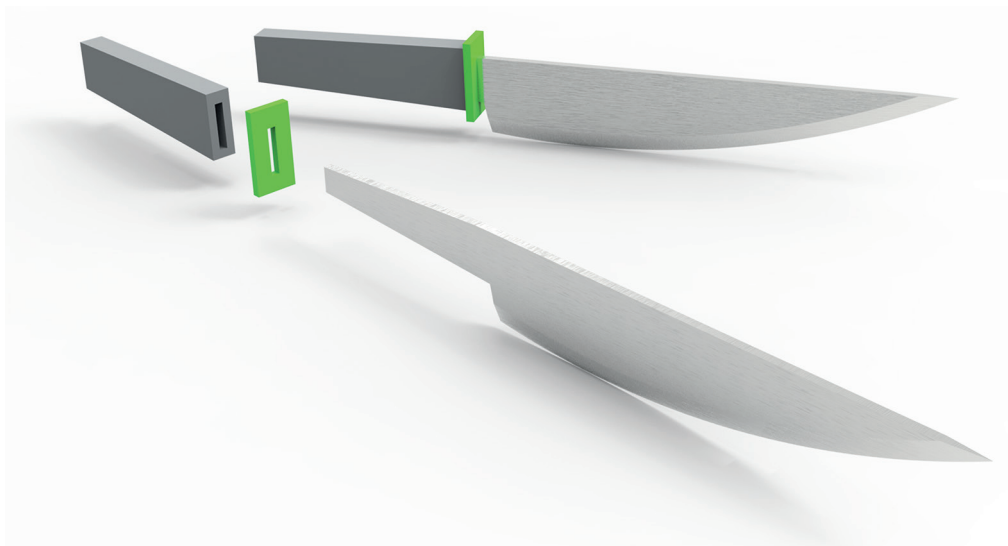

Plan

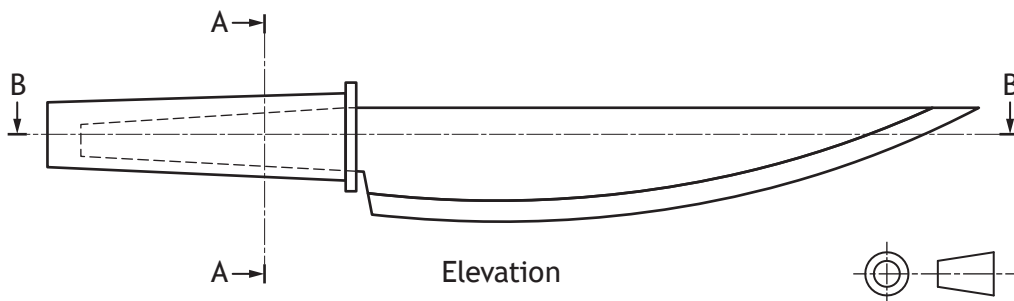

Elevation

- (i) Identify the correct sectional end elevation A-A by ticking (✓) a box below.

1





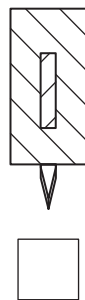





* X 8 3 5 7 5 0 1 0 8 *

MARKS

DO NOT
WRITE IN
THIS
MARGIN

1

1. (i) (continued)

(ii) Identify the correct sectional plan B-B by ticking (✓) a box below.

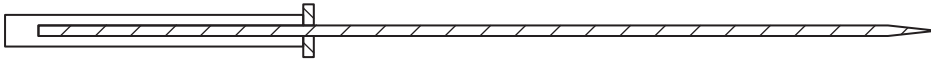
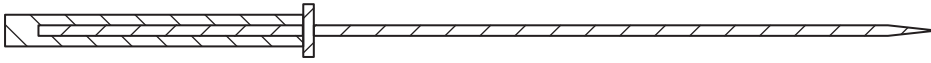

* X 8 3 5 7 5 0 1 0 9 *

2. A recipe app has been produced. The graphic artist was asked to ensure that the graphic layout was easy to follow.



- (a) Describe three ways, other than the numbering system, that the graphic artist has graphically communicated the **sequence** of the recipe shown above.

3

- (b) Describe two benefits that producing a recipe app, rather than physically printing a recipe book, would have for the environment.

2



2. (continued)

The app also contains an additional feature that analyses individual ingredients and calculates the overall health rating of the recipe.

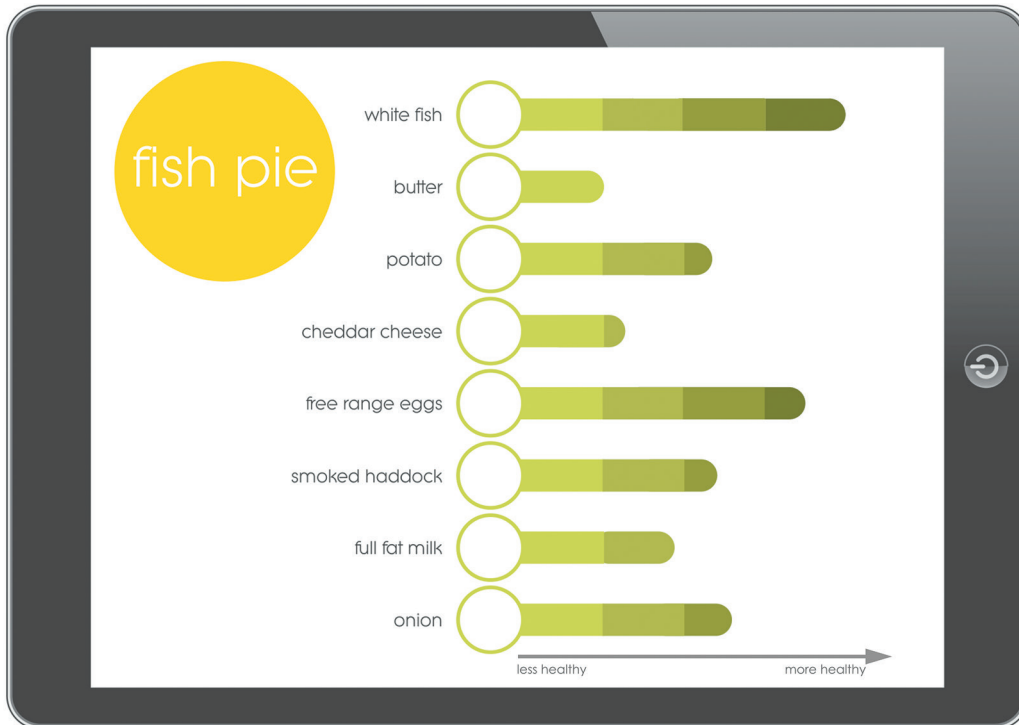

(c) Name the type of graph or chart that was used in the graphic shown above. 1

(d) Describe one way that the graphic artist has graphically communicated the health rating of the individual ingredients. 1

[Turn over



* X 8 3 5 7 5 0 1 1 1 *

2. (continued)

Two different sets of statistics that have been provided are shown below.

Statistics A	
Nutritional Data – Nuts	
Cashew	170 Calories, 13g Fat, 8g Carb, 5g Protein, 1g Fibre
Hazelnut	180 Calories, 18g Fat, 4g Carb, 4g Protein, 2g Fibre
Peanut	170 Calories, 14g Fat, 6g Carb, 7g Protein, 2g Fibre
Walnut	210 Calories, 20g Fat, 6g Carb, 5g Protein, 2g Fibre

Statistics B	
Healthy diet plan	
Fruit and Vegetables	33%
Carbohydrates	33%
Protein	12%
Milk and Dairy	15%
Fats and sugars	7%

- (e) (i) State the most suitable type of informational graphic to present the data shown in **Statistics A**. 1

- (ii) Explain why this is an appropriate type of informational graphic to present. 1

- (f) (i) State the most suitable type of informational graphic to present the data in **Statistics B**. 1

- (ii) Explain why this is an appropriate type of informational graphic to present. 1



[Turn over for next question

DO NOT WRITE ON THIS PAGE



* X 8 3 5 7 5 0 1 1 3 *

3. A modular lighting system is shown below. There are three sizes of coloured lighting pods that can be arranged in a variety of ways. A rendered 3D CAD illustration is shown below.

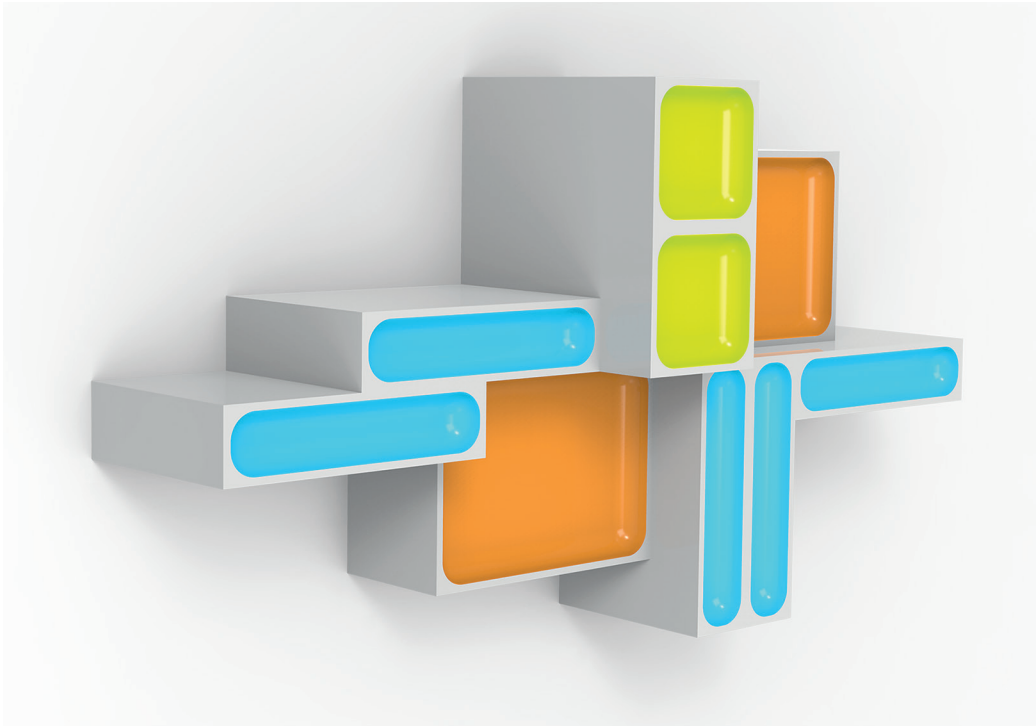

An orthographic drawing of one of the orange lighting pods is shown below.

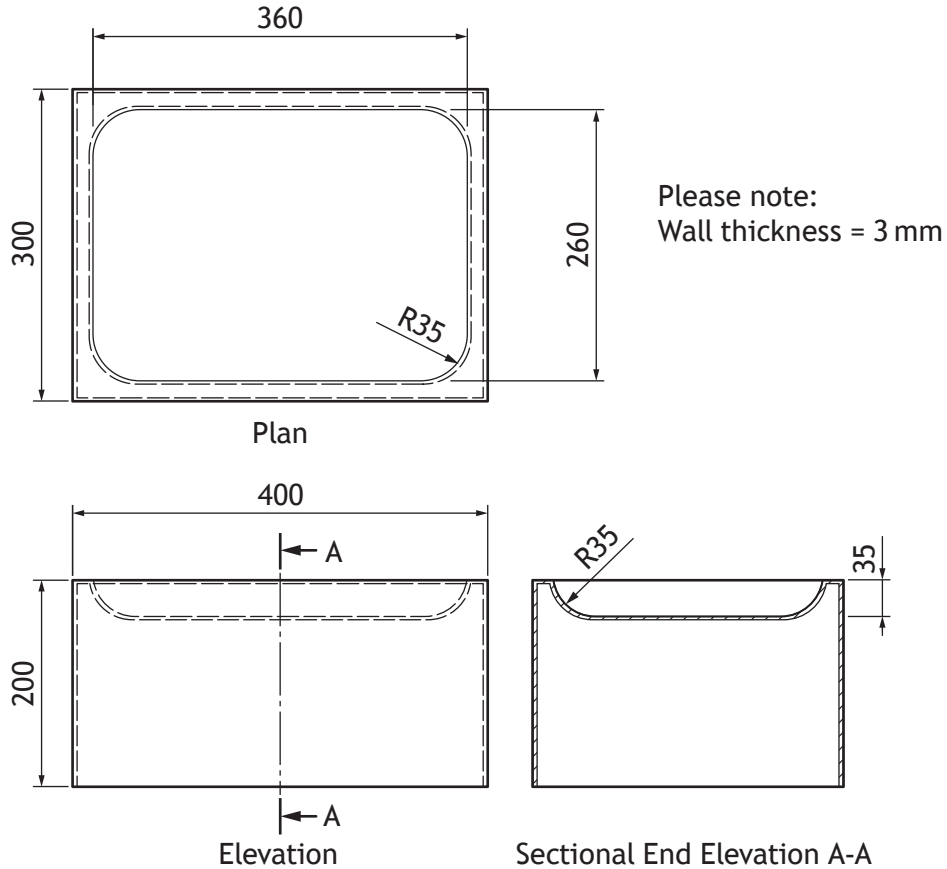

* X 8 3 5 7 5 0 1 1 4 *

3. (continued)

MARKS

DO NOT
WRITE IN
THIS
MARGIN

- (a) Describe, using the correct dimensions and 3D CAD modelling terms, how you would use 3D CAD software to model the orange lighting pod. You may use sketches to support your answer.

6



* X 8 3 5 7 5 0 1 1 5 *

3. (continued)

Orthographic assembly views of an arrangement of the lighting system are shown below. Hidden detail removed for clarity.

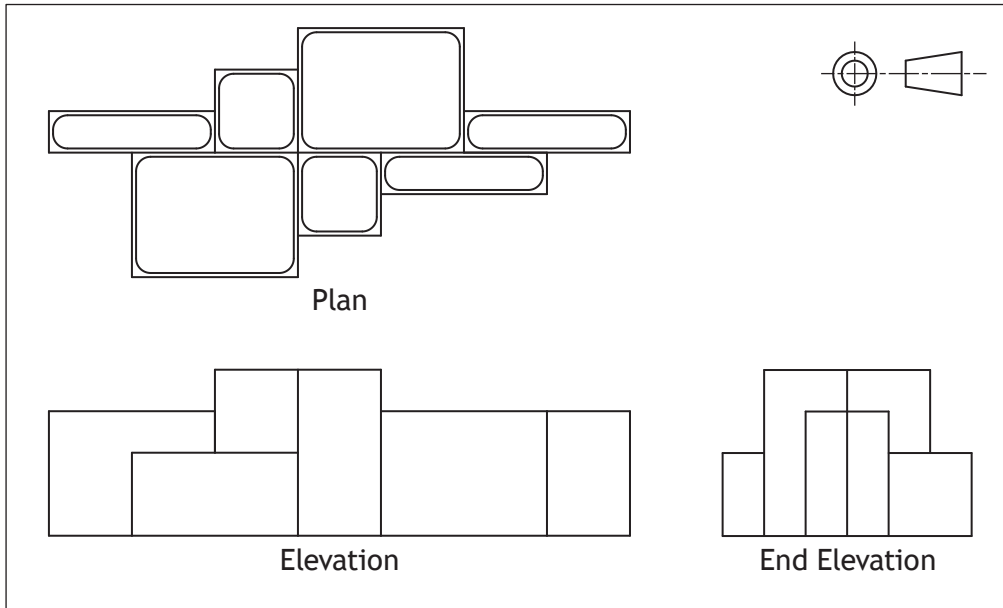

3. (continued)

(b) Identify, using a tick (✓), the two pictorial assembly drawings that match the arrangement in the orthographic assembly drawing shown.

2

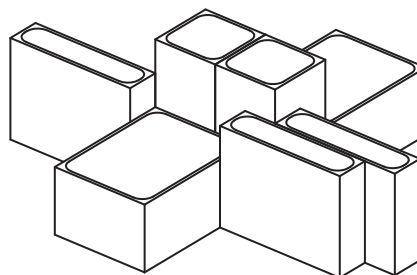
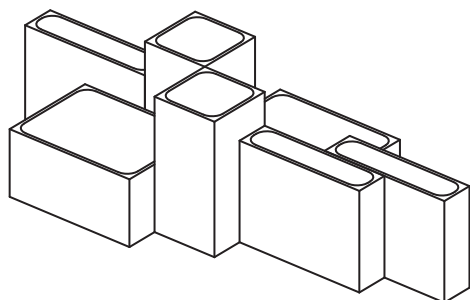
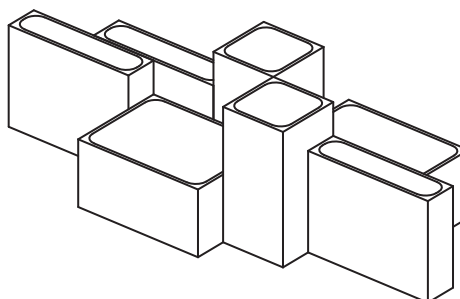
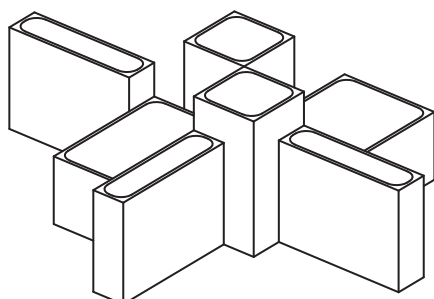
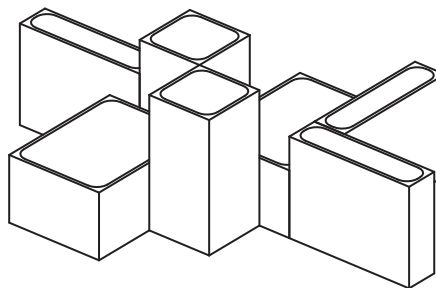
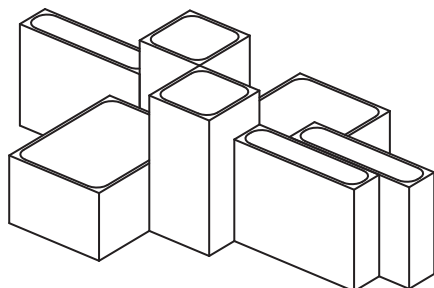

[Turn over



* X 8 3 5 7 5 0 1 1 7 *

3. (continued)

MARKS
DO NOT
WRITE IN
THIS
MARGIN

A 2D CAD line drawing, produced using 2D CAD software, and a 3D CAD model of a control panel for the lighting system are shown below.

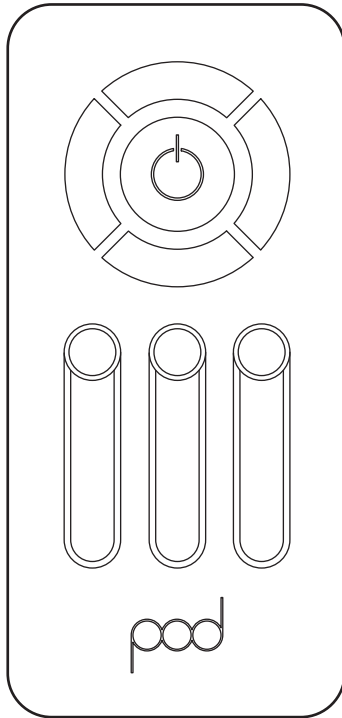

2D CAD Line Drawing

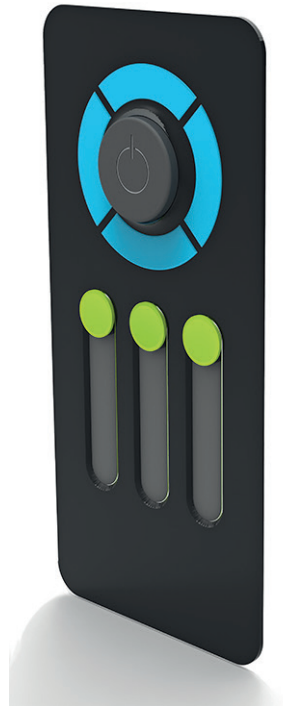

3D CAD Model

- (c) Explain why the 2D CAD line drawing can be produced more quickly than the 3D CAD model of the control panel. 1

- (d) Describe two benefits of a 3D CAD model over a 2D CAD drawing. 2



3. (continued)

MARKS
DO NOT WRITE IN THIS MARGIN

To create the features of the control panel a number of 2D CAD tools were used.

(e) State the name of the single CAD tool used in each case.

6

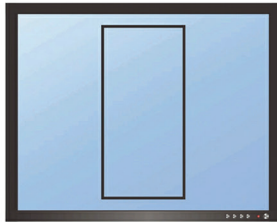
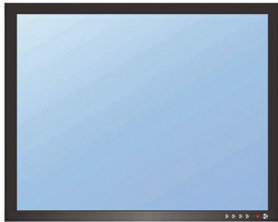

(i) Tool used

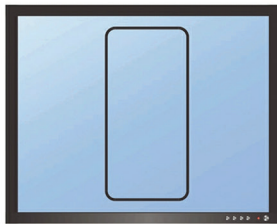
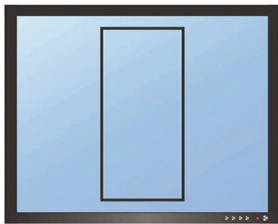

(ii) Tool used



(iii) Tool used

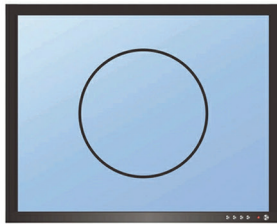
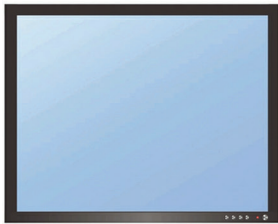

(iv) Tool used

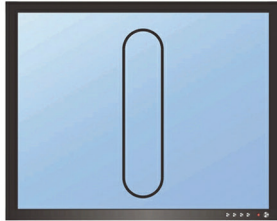

(v) Tool used

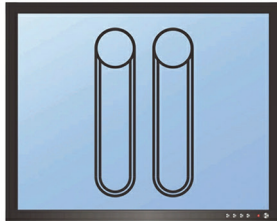
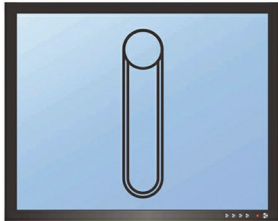

(vi) Tool used



* X 8 3 5 7 5 0 1 1 9 *

3. (continued)

Three line types that will be used to complete the 2D CAD drawings to British Standard conventions are shown below.

(f) State the uses of the following line types.

(i) A chain thin line

1



(ii) A continuous thick line

1



(iii) A long dash dotted thin line, thick at ends.

1



The 2D CAD drawings are to be drawn using a scale.

(g) Explain what is meant by the term scale 2:1.

1



[Turn over for next question

DO NOT WRITE ON THIS PAGE



* X 8 3 5 7 5 0 1 2 1 *

4. A speaker has been designed using 3D CAD software. A rendered illustration is shown below.



A pictorial view of one of the speaker components is shown below.

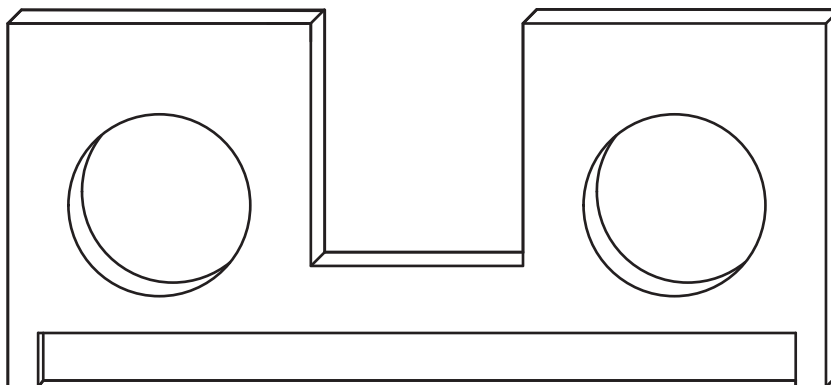

- (a) State the type of pictorial view shown above.

1



4. (continued)

A working drawing of the speaker assembly is shown below.

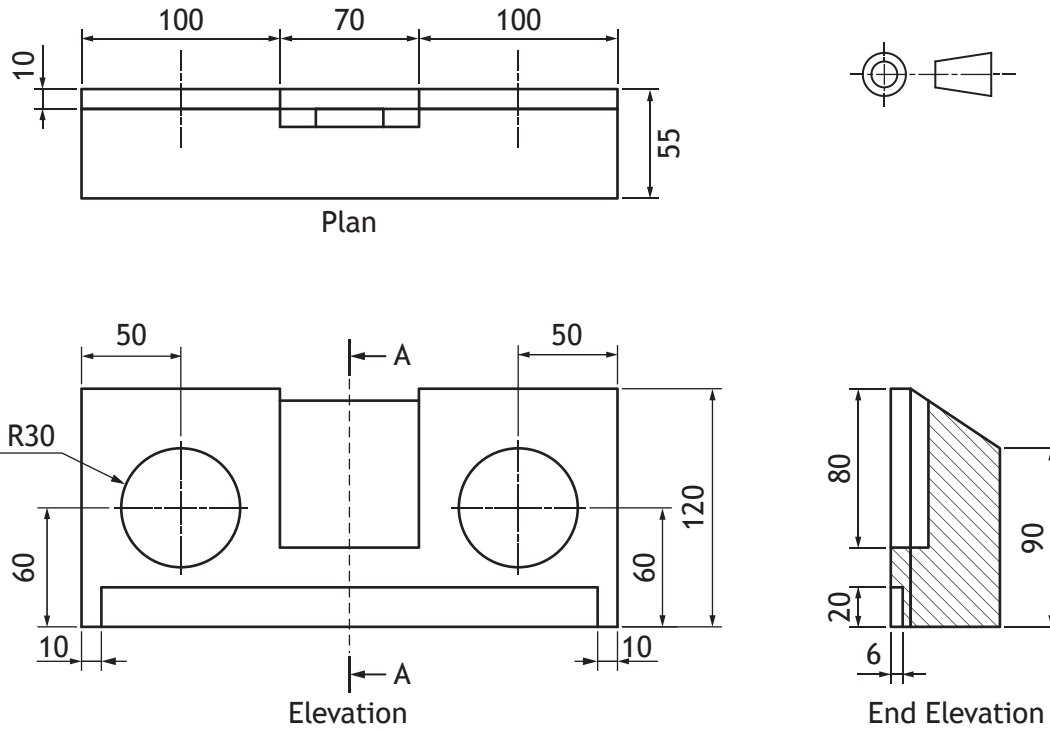

Five pieces of information in the working drawing do not adhere to British Standard conventions.

(b) State the five errors found in this drawing.

5

You may annotate the orthographic drawing to support your answer.

4. (continued)

Rubber feet are to be added to the base. Orthographic views and 3D illustrations of a rubber foot are shown below.

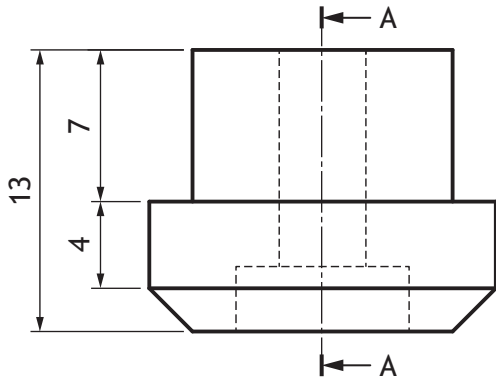
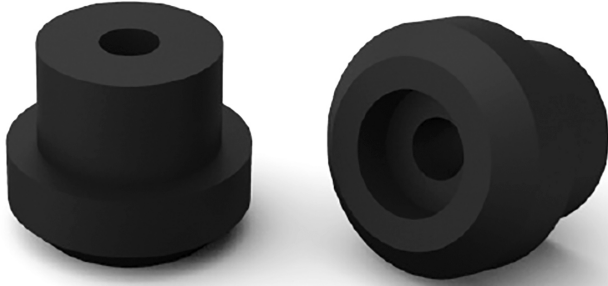

Elevation

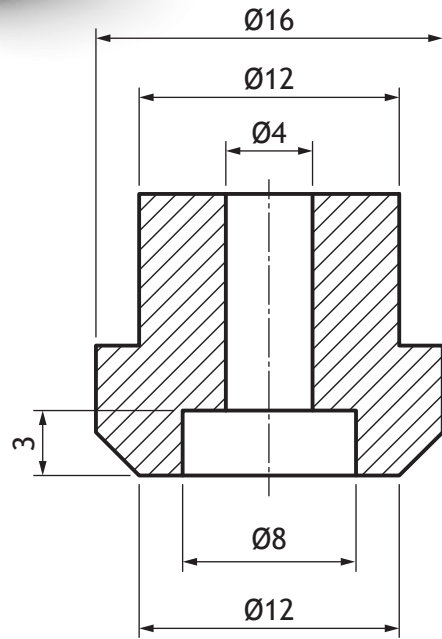

Sectional End Elevation A-A



* X 8 3 5 7 5 0 1 2 4 *

4. (continued)

- (c) Describe, using the correct dimensions and 3D CAD modelling terms, how the rubber foot, shown opposite, would be produced.

3

You may use sketches to support your answer.

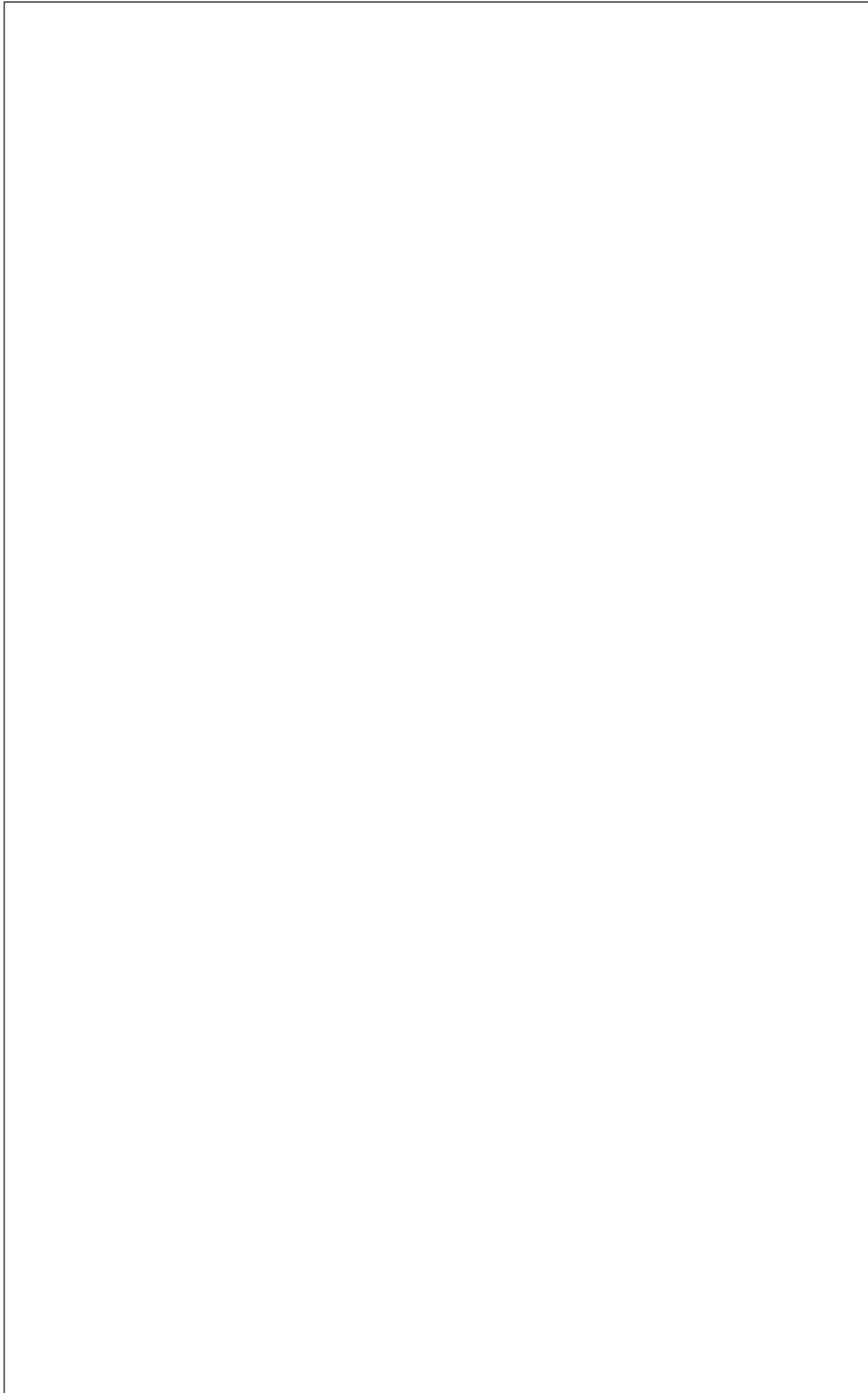

* X 8 3 5 7 5 0 1 2 5 *

4. (continued)

The orthographic drawings of the speaker were shared online.

(d) Describe two benefits of sharing these orthographic drawings online.

2

(e) Explain why it would be useful to adhere to British Standard conventions and protocols when sharing these types of drawings.

2

(f) Explain the purpose of the following types of production drawings.

(i) Sectional views _____

1

(ii) Assembly drawings _____

1



[Turn over for next question

DO NOT WRITE ON THIS PAGE



* X 8 3 5 7 5 0 1 2 7 *

5. Many companies now specialise in applying promotional graphic posters, to advertise services to the public, around commercial vehicles.

A finished layout for a small building company is shown below.



* X 8 3 5 7 5 0 1 2 8 *

5. (continued)

The design work for the layout was produced by a graphic designer.

(a) Describe two ways in which the graphic designer used the following design elements and principles to enhance the layout.

(i) Line

2

(ii) Dominance

2

(iii) Colour

2

(iv) Unity

2

[Turn over



* X 8 3 5 7 5 0 1 2 9 *

5. (continued)

Vehicles were traditionally hand painted to include information about a company. Modern processes involve printing promotional graphics which are then applied to a vehicle.



Traditional painting technique



Modern printed technique

(b) Describe two advantages to the client of modern printing techniques over traditional painting techniques.

2

[Turn over for next question

DO NOT WRITE ON THIS PAGE



* X 8 3 5 7 5 0 1 3 1 *

6. A graphic designer submitted a draft layout for an architectural magazine article to the editor. The draft is shown below.



The editor provided some feedback to the graphic designer on how to improve the layout.

- (a) Describe, using the feedback shown below, four improvements the graphic designer should make to the layout using **Desktop Publishing techniques**.

(i) *The word 'house' in the heading is difficult to see* 1

(ii) *The large column of extended text makes it difficult to read* 1

(iii) *The bottom image would look better without the sky in the background* 1

(iv) *The body text is too close to the edge of the paper* 1



6. (continued)

The graphic designer used a sans serif font for the heading.

- (b) State two reasons why the graphic designer has chosen a sans serif font for the heading.

2

When inserting an image, the graphic designer used the handles of the image to increase its size. This resulted in the image being out of proportion, shown below.



- (c) Describe how the graphic designer could have resized the image without altering the proportions.

1



* X 8 3 5 7 5 0 1 3 3 *

6. (continued)

During the production of the layout, using desktop publishing software, the graphic designer used **guidelines**.

- (d) Describe two advantages of using guidelines in the creation of promotional layouts.

2

[END OF QUESTION PAPER]



* X 8 3 5 7 5 0 1 3 4 *

MARKS

DO NOT
WRITE IN
THIS
MARGIN

ADDITIONAL SPACE FOR ANSWERS



* X 8 3 5 7 5 0 1 3 5 *

MARKS

DO NOT
WRITE IN
THIS
MARGIN

ADDITIONAL SPACE FOR ANSWERS



* X 8 3 5 7 5 0 1 3 6 *

ACKNOWLEDGEMENTS

Question 5 (top image) – Image is taken from <https://signsandpainting.co.uk/traditional-signwriter/>. SQA has made every effort to trace the owners of copyright materials in this question paper, and seek permissions. We will be happy to incorporate any missing acknowledgements. Please contact question.papers@sqa.org.uk.

Question 5 (bottom image) – Image is taken from <https://www.popularmechanics.com/cars/how-to/g1105/how-to-vinyl-wrap-a-car/>.

SQA has made every effort to trace the owners of copyright materials in this question paper, and seek permissions. We will be happy to incorporate any missing acknowledgements. Please contact question.papers@sqa.org.uk.

Question 6 – Three images by alexandre zveiger/Shutterstock.com



* X 8 3 5 7 5 0 1 3 7 *