

Irvine Royal Academy—Technical Department
S3/S4 Graphic Communication Homework
Developments, True Shapes, Hexagons

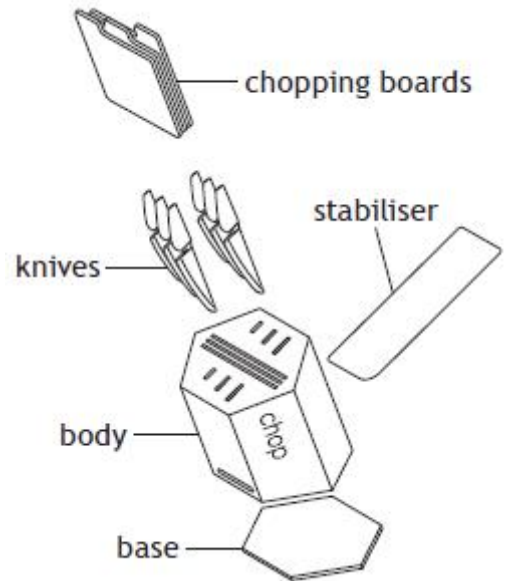

A kitchen knife storage container, which also has spaces for chopping boards and a wooded stabiliser is shown to the left.

The body is made from sheet metal. A CAD technician produced the rendered 3D CAD illustration as well as the pictorial line drawing shown to the right.



A 3D CAD model rather than a physical model of the storage system was created during the development stage.

1 State **two** reasons why a 3D CAD model was more suitable than a physical model

To produce the CAD model the CAD technician was given information about the storage system. One dimension stated: A/F 300mm. [2]

2 What does A/F mean?

The CAD technician has been asked to produce an appropriate surface development for the storage system and identify where key features will be placed. The drawing to the right indicates the position of the word **chop**, the **Exit Hole** and the **Entry Hole**.

The graphic below has each side identified by the letters A-F.

3 Select the correct letter that indicates the surface that has the following on/through it:

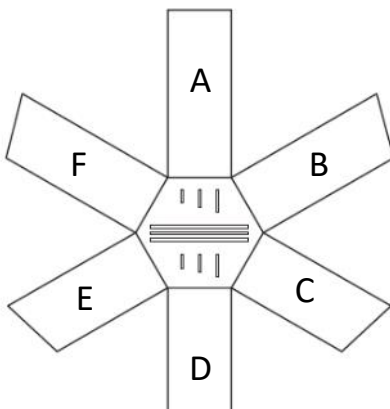

i The word **chop** _____

ii The **Entry Hole** _____

iii The **Exit Hole** _____ [3]

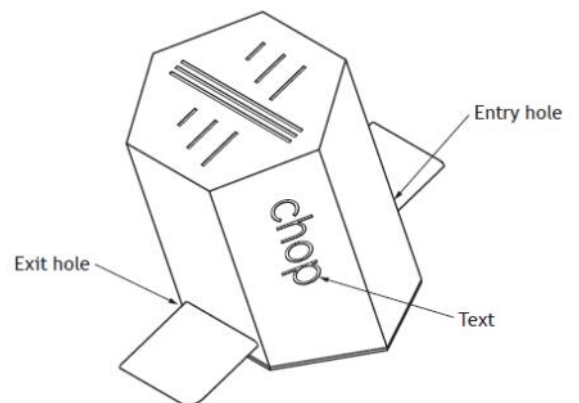

(Continued on next page)

To aid the production of the storage system, the CAD technician was asked to complete the orthographic drawing shown to the right.

The hidden detail and slots have been removed for clarity.

4 Which of the following Elevations, A, B, C or D, is the correct one?

_____ [1]

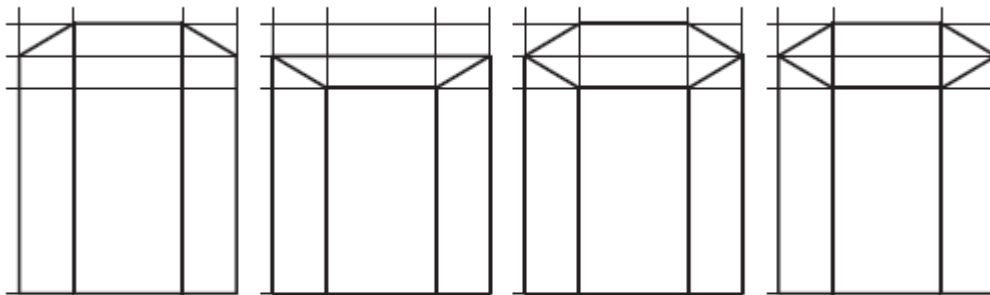
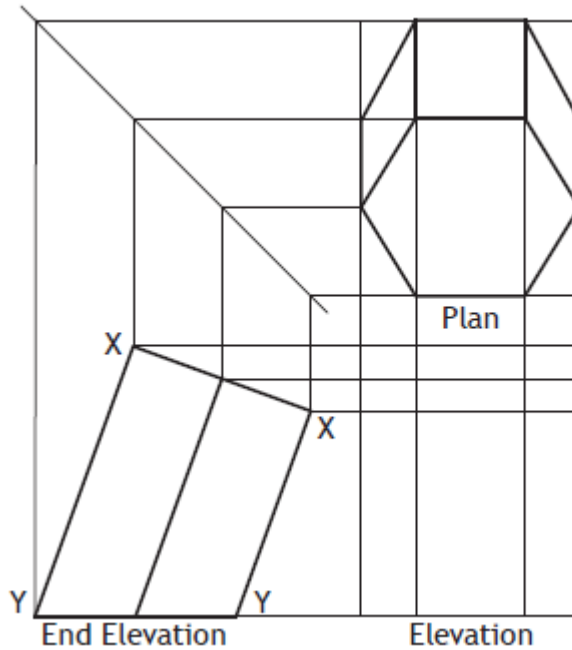

A

B

C

D

True Shapes of surfaces X-X and Y-Y are required.

5 Which of the following is the true shape of X-X?

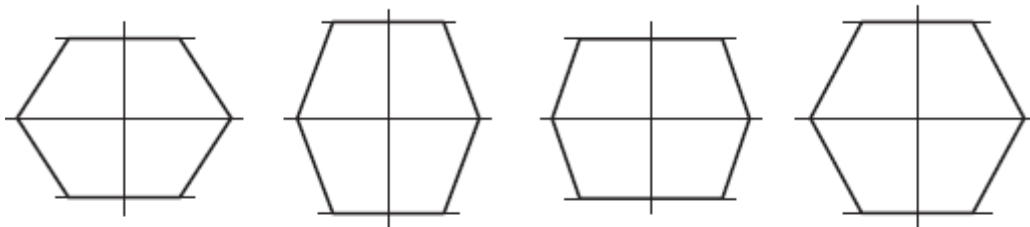

W

X

Y

Z

Answer: _____ [1]

6 Why do **True Shapes** sometimes need to be worked out on a drawing?

_____ [1]

(Continued on next page)

Irvine Royal Academy—Technical Department
S3/S4 Graphic Communication Homework
Developments, True Shapes, Hexagons

The CAD technician was then asked to provide surface developments of the body of the knife block, without the top.

7 Identify the two correct surface developments, shown below, of the knife block when opened out at surface generators 'A' and 'B'. You should refer to the orthographic drawing below.

(i) When opened out at generator A, the correct surface development is view:

(ii) When opened out at generator B, the correct surface development is view:

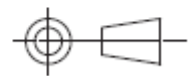
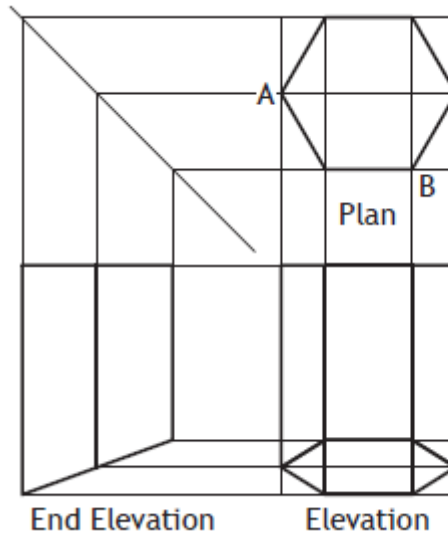

_____ [2]

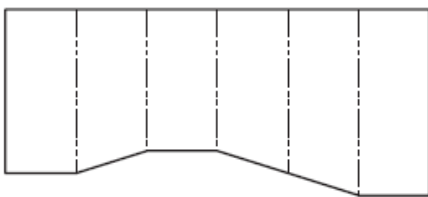

1.

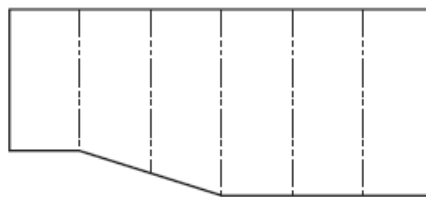

2.

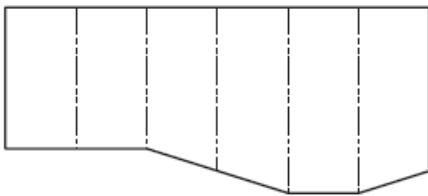

3.

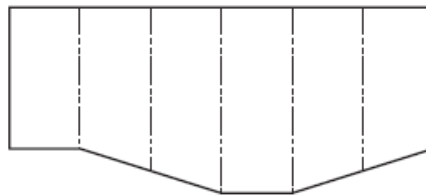

4.

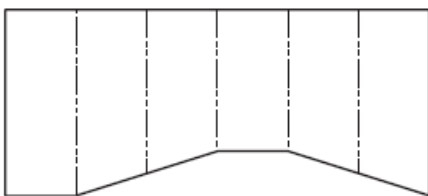

5.

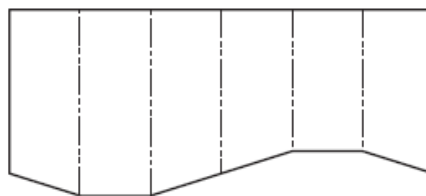

6.

A number of the knife blocks are to be produced from a single sheet of material.

8 Explain, in terms of environmental impact, why it is important to carefully consider the layout of multiple parts.
